



DENRACLE[®]

2020~2021

Product Catalog

Implant Parts

Page Compatible Systems / DENRACLE System Code

[P.06](#) Anthogyr® Axiom® / **23**

[P.06](#) BBC® Mytis Arrow / **43**

[P.07](#) Biohorizons® Tapered Internal/External® / **GH**

[P.08](#) Dentium® Superline / **GE**

[P.09](#) Dentsply Astra Tech OsseoSpeed® / **GS**

[P.10](#) Dentsply AstraTech EV / **17**

[P.11](#) Dentsply Friadent/XIVE® / **GX**

[P.12](#) DIO® SM / **GD**

[P.13](#) DIO® UF II Narrow / **41**

[P.13](#) DIO® UF II / **46**

[P.14](#) KEYSTONE Prima Connex® / **GC**

[P.15](#) Megagen® AnyRidge® HEX / **15**

[P.15](#) Megagen® EZ / **14**

[P.16](#) Megagen® Mini / **44**

[P.16](#) MIS® Seven® / **35**

[P.17](#) Nobel Biocare® NobelActive® /Conical / **GA**

[P.18](#) Nobel Biocare® Brånemark System® / **GB**

[P.19](#) Nobel Biocare® Nobel Replace® / **GR**

[P.20](#) Osstem® TS3/Hiossen / **GO**

Page Compatible Systems / DENRACLE System Code

[P.21](#) Straumann® Bone Level / **GN**

[P.22](#) Straumann® Tissue Level / **GT**

[P.23](#) SIC® Invent / **42**

[P.24](#) Zimmer BIOMET 3i® Certain® / **G3**

[P.25](#) Zimmer® Tapered Screw-Vent® / **GZ**

Accessories

[P.27](#) Accessories

Cutting Tools

• Regular Coating

Page Compatible Systems

[P.30](#) VHF® OAL40/OAL35

[P.31](#) WIELAND® Zenotec/Mini

[P.32](#) ROLAND® • AMANN GIRRBACH®

[P.33](#) imes-icore®

[P.39](#) ZIRKONZAHN® M4 • CERCON BRAIN EXPERT®

[P.40](#) ARUM®

[P.42](#) SIRONA® • YENADENT

[P.43](#) 3M-ESPE®

• Diamond Coating

Page Compatible Systems

[P.46](#) VHF® OAL40

[P.46](#) ROLAND®

[P.47](#) AMANN GIRRBACH

[P.47](#) imes-icore®

[P.48](#) Kavo

Who We Are

Green DenTech Co. Ltd. was established in early 2009 with the ability of precision manufacture technique of titanium alloy and stainless steel, PEEK, PMMA, and POM. GDT's history with high-precision quality parts spans over two decades. We developed cutting edge dental implants and dental accessories. Our purpose is to offer high-end dentistry solution to end-users and develop high-quality products to OEM/ODM customers.

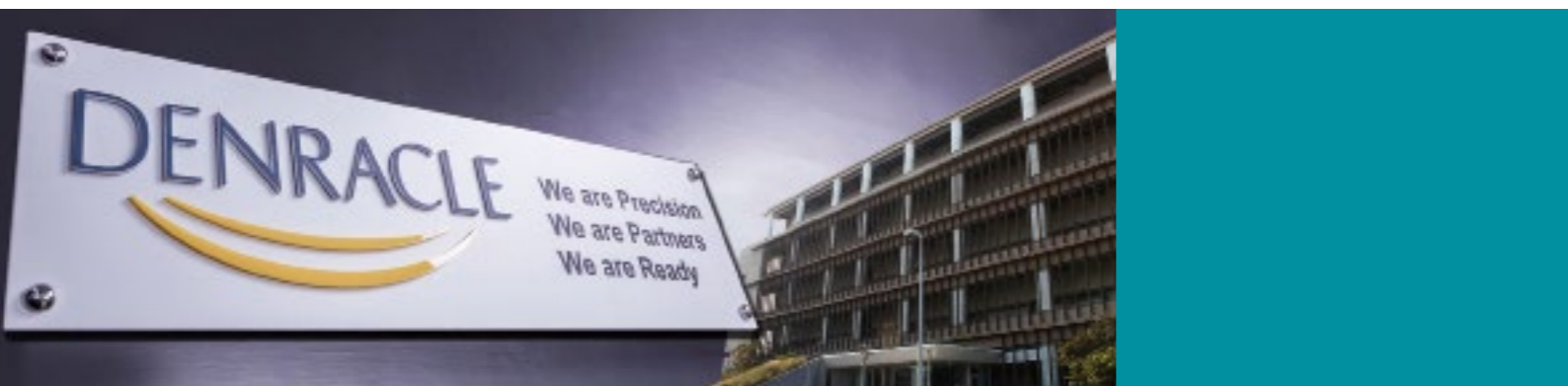

DENRACLE – The Brand

DENRACLE was a brand owned by Green DenTech Co., Ltd. in Taiwan. DENRACLE is a combination of Dental, Miracle, and Smile which are three essential elements as well as the spirit of the brand. All DENRACLE products are of the elaborated design and precision milling out of the finest quality material to meet the demand of global customers.



DENRACLE COMPATIBILITY CHART

Compatible Brand	System	DENRACLE Code	Platform
Anthogyr	Axiom (AA)	23	—
BBC	Mytis Arrow	43	C Type 35
Biohorizons	Tapered internal	GH	3.5
			4.0
			5.0
	External		3.5
			4.0
			5.0
Dentium	Superline	GE	mini
			regular
Dentsply	AstraTech OsseoSpeed	GS	3.0
			3.5/4.0
			4.5/5.0
	AstraTech EV		3.0
			3.6
			4.2
Friadent/XIVE	GX	4.8	
		5.4	
		3.0	
		3.4	
		3.8	
		4.5	
DIO	SM	GD	5.5
			mini
			regular
KEYSTONE	Prima Connex	GC	3.0
			4.0
			4.0
Megagen	AnyRidge HEX	15	SD
			RD
			WD
			4.0
Zimmer Biomet 3i	Certain	G3	3.5
			4.1
			5.0
Zimmer	Tapered Screw-Vent	GZ	4.5
			5.7
			3.0

Compatible Brand	System	DENRACLE Code	Platform	
MIS	Seven	35	NP	
			SP	
			WP	
Nobel Biocare	Active/Conical	GA	NP	
			RP	
	Branemark	GB	NP	
			RP	
			WP	
			NP	
Replace	GR	RP		
		WP		
		6.0		
		3.5		
Osstem/Hiossen	TS3	GO	4.0	
			NC	
Straumann	Bone Level	GN	RC	
			NN	
	Tissue Level		GT	RN
				WN
SIC	Invent	42	3.3	
			4.2	
Zimmer Biomet 3i	Certain	G3	3.4	
			4.1	
			5.0	
Zimmer	Tapered Screw-Vent	GZ	3.5	
			4.5	
			5.7	

*If your required systems are not on the Chart, please contact us.

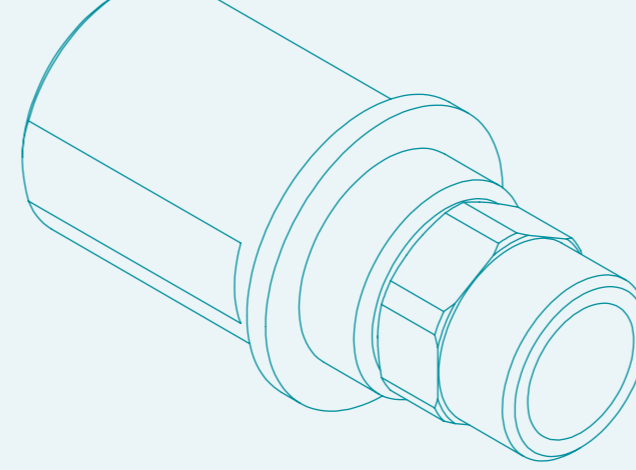

DENRACLE®

Implant Parts

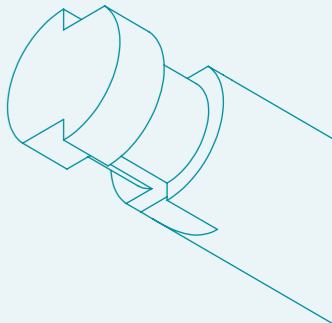

Compatible with **Anthogyr® Axiom®**

23

Product		
Screw		2300SM16
Intra-oral Scan Body		2300U012L
Blank Abutment		2300A9A1
Digital Analog		2300N001

Compatible with **BBC® Mytis Arrow**

43

Product		<i>C Type35</i>
Screw		4300SM20
Intra-oral Scan Body		4335U012L
Blank Abutment		4335A9A1
Digital Analog		4335N001

Compatible with **Biohorizons® Tapered Internal/External®**

GH

Product				3.5	4.0	5.0
Screw			IN	H00S172-IN	H00S172-IN	H00S172-IN
			EX	H01S172-EX	H00S264-EX	H00S264-EX
Scan Body			IN	H35U001-IN	H40U001-IN	H50U001-IN
			EX	H35U002-EX	H40U002-EX	H50U002-EX
Intra-oral Scan Body			IN	H35U012L-IN	H40U012L-IN	H50U012L-IN
Ti-Base		<ul style="list-style-type: none"> • 4mm Non-Engage • 4mm Engage • 7mm Non-Engage • 7mm Engage 	IN	H35BC00-IN	H40BC00-IN	H50BC00-IN
				H35BC10-IN	H40BC10-IN	H50BC10-IN
				H35BC01-IN	H40BC01-IN	H50BC01-IN
				H35BC11-IN	H40BC11-IN	H50BC11-IN
		<ul style="list-style-type: none"> • 4mm Non-Engage • 4mm Engage • 7mm Non-Engage • 7mm Engage 	EX	H35BC00-EX	H40BC00-EX	H50BC00-EX
				H35BC10-EX	H40BC10-EX	H50BC10-EX
				H35BC01-EX	H40BC01-EX	H50BC01-EX
				H35BC11-EX	H40BC11-EX	H50BC11-EX
Blank Abutment			IN	H35A901	H40A901	H50A901
			IN	H35A9A1	H40A9A1	H50A9A1
			EX	H35A9A2	H40A9A2	H50A9A2
			EX	H35A902	H40A902	H50A902
Analog			IN	GH-35-IN	GH-40-IN	GH-50-IN
			EX	GH-35-EX	GH-40-EX	GH-50-EX
Digital Analog			IN	H35N001	H40N001	H50N001

Compatible with **Dentium® Superline**

Compatible with **Dentsply Astra Tech OsseoSpeed®**

GE

Product			<i>Mini</i>	<i>Regular</i>
Screw			E00SM20	E00SM20
Scan Body			EMIU001	EREU001
Intra-oral Scan Body			EMIU012L	EREU012L
Ti-Base		• 4mm Non-Engage	EMIBC00	EREBC00
		• 4mm Engage	EMIBC10	EREBC10
		• 7mm Non-Engage	EMIBC01	EREBC01
		• 7mm Engage	EMIBC11	EREBC11
Blank Abutment		Φ 10mm×15mm	EMIA901	EREA901
		Φ 10mm×20mm	EMIA9A1	EREA9A1
		Φ 15mm×17mm	EMIA902	EREA902
Analog			GE-MI-N	GE-RE-N
Digital Analog			EMIN001	EREN001

GS

Product			<i>3.0</i>	<i>3.5/4.0</i>	<i>4.5/5.0</i>
Screw			S00SM14	S00SM16	S00SM20
Scan Body			S30U001	S35U001	S45U001
Intra-oral Scan Body			S30U012L	S35U012L	S45U012L
Ti-Base		• 4mm Non-Engage	S30BC00	S35BC00	S45BC00
		• 4mm Engage	S30BC10	S35BC10	S45BC10
		• 7mm Non-Engage	S30BC01	S35BC01	S45BC01
		• 7mm Engage	S30BC11	S35BC11	S45BC11
Blank Abutment		Φ 10mm×15mm	S30A901	S35A901	S45A901
		Φ 10mm×20mm	S30A9A1	S35A9A1	S45A9A1
		Φ 15mm×17mm		S35A902	S45A902
Analog			GS-30-N	GS-35-N	GS-45-N
Digital Analog			S30N001	S35N001	S45N001

Compatible with **Dentsply AstraTech EV**

17

Product		3.0	3.6	4.2	4.8	5.4
Screw		1700SM14	1700SM16	1700SM18	1700SM20	1700SM20
Intra-oral Scan Body		1730U012L	1736U012L	1742U012L	1748U012L	1754U012L
Blank Abutment		1730A9A1	1736A9A1	1742A9A1	1748A9A1	1754A9A1
Digital Analog		1730N001	1736N001	1742N001	1748N001	1754N001

Compatible with **Dentsply Friadent/XIVE®**

GX

Product			3.0	3.4	3.8	4.5	5.5
Screw			X00SM14	X00SM16	X00SM16	X00SM16	X00SM16
Scan Body			X30U001	X34U001	X38U001	X45U001	X55U001
Intra-oral Scan Body			X30U012L	X34U012L	X38U012L	X45U012L	X55U012L
Ti-Base		• 4mm Non-Engage	X30BC00	X34BC00	X38BC00	X45BC00	X55BC00
		• 4mm Engage	X30BC10	X34BC10	X38BC10	X45BC10	X55BC10
		• 7mm Non-Engage	X30BC01	X34BC01	X38BC01	X45BC01	X55BC01
		• 7mm Engage	X30BC11	X34BC11	X38BC11	X45BC11	X55BC11
Blank Abutment		Φ10mm×15mm	X30A901	X34A901	X38A901	X45A901	X55A901
		Φ10mm×20mm	X30A9A1	X34A9A1	X38A9A1	X45A9A1	X55A9A1
		Φ15mm×17mm	X30A902	X34A902	X38A902	X45A902	X55A902
Analog			GX-30-N	GX-34-N	GX-38-N	GX-45-N	GX-55-N
Digital Analog			X30N001	X34N001	X38N001	X45N001	X55N001

Compatible with **DIO® SM**

Product			<i>Mini</i>	<i>Regular</i>
Screw			D00SM18	D00SM20
Scan Body			DMIU001	DREU001
Intra-oral Scan Body			DMIU012L	DREU012L
Ti-Base		• 4mm Non-Engage	DMIBC00	DREBC00
		• 4mm Engage	DMIBC10	DREBC10
		• 7mm Non-Engage	DMIBC01	DREBC01
		• 7mm Engage	DMIBC11	DREBC11
Blank Abutment		Φ10mm×15mm	DMIA901	DREA901
		Φ10mm×20mm	DMIA9A1	DREA9A1
		Φ15mm×17mm	DMIA902	DREA902
Analog			GD-40-N	GD-45-N
Digital Analog			D40N001	D45N001



Compatible with **DIO® UF II Narrow**

Product		<i>3.0</i>
Screw		4100SM14
Intra-oral Scan Body		4130U012L
Blank Abutment		4130A9A1
Digital Analog		4130N001

Compatible with **DIO® UF II**

Product		<i>4.0</i>
Screw		4600SM20
Intra-oral Scan Body		4640U012L
Blank Abutment		4640A9A1
Digital Analog		4640N001

Compatible with **KEYSTONE Prima Connex®**

Product			SD	RD	WD
Screw			C00SM18	C00SM18	C00SM18
Scan Body			CSDU001	CRDU001	CWDU001
Intra-oral Scan Body			CSDU012L	CRDU012L	CWDU012L
Ti-Base		• 4mm Non-Engage	CSDBC00	CRDBC00	CWDBC00
		• 4mm Engage	CSDBC10	CRDBC10	CWDBC10
		• 7mm Non-Engage	CSDBC01	CRDBC01	CWDBC01
		• 7mm Engage	CSDBC11	CRDBC11	CWDBC11
Blank Abutment		Φ10mm×15mm	CSDA901	CRDA901	CWDA901
		Φ10mm×20mm	CSDA9A1	CRDA9A1	CWDA9A1
		Φ15mm×17mm	CSDA902	CRDA902	CWDA902
Analog			GC-SD-N	GC-RD-N	GC-WD-N
Digital Analog			CSDN001	CRDN001	CWDN001

Compatible with **Megagen® AnyRidge® HEX**

Product		4.0
Screw		1500SM18
Intra-oral Scan Body		1540U012L
Blank Abutment		1540A9A1
Digital Analog		1540N001

Compatible with **Megagen® EZ**

Product		3.5	4.1
Screw		1400SM16	1400SM20
Intra-oral Scan Body		1435U012L	1441U012L
Blank Abutment		1435A9A1	1441A9A1
Digital Analog		1435N001	1441N001

Compatible with **Megagen® Mini**

44

Product		3.0
Screw		4400SM14
Intra-oral Scan Body		4430U012L
Blank Abutment		4430A9A1
Digital Analog		4430N001

Compatible with **MIS® Seven®**

35

Product		NP	SP	WP
Screw		3500SM16	3500S172	3500S172
Intra-oral Scan Body		35NPU012L	35SPU012L	35WPU012L
Blank Abutment		35NPA9A1	35SPA9A1	35WPA9A1
Digital Analog		35NPN001	35SPN001	35WPN001

Compatible with **Nobel Biocare® NobelActive® /Conical**

GA

Product			NP	RP
Screw			A00SM16	A00SM20
Scan Body			ANPU001	ARPU001
Intra-oral Scan Body			ANPU012L	ARPU012L
Ti-Base		• 4mm Non-Engage	ANPBC00	ARPBC00
		• 4mm Engage	ANPBC10	ARPBC10
		• 7mm Non-Engage	ANPBC01	ARPBC01
		• 7mm Engage	ANPBC11	ARPBC11
Blank Abutment		Φ10mm×15mm	ANPA901	ARPA901
		Φ10mm×20mm	ANPA9A1	ARPA9A1
		Φ15mm×17mm		ARPA902
Analog			GA-NP-N	GA-RP-N
Digital Analog			ANPN001	ARPN001

Compatible with **Nobel Biocare® Brånemark System®**

Product			<i>NP</i>	<i>RP</i>	<i>WP</i>
Screw			B00SM16	B00SM20	B00SM25
Scan Body			BNPU001	BRPU001	BWPU001
Intra-oral Scan Body			BNPU012L	BRPU012L	BWPU012L
Ti-Base		• 4mm Non-Engage	BNPBC00	BRPBC00	BWPBC00
		• 4mm Engage	BNPBC10	BRPBC10	BWPBC10
		• 7mm Non-Engage	BNPBC01	BRPBC01	BWPBC01
		• 7mm Engage	BNPBC11	BRPBC11	BWPBC11
Blank Abutment		Φ 10mm×15mm	BNPA901	BRPA901	BWPA901
		Φ 10mm×20mm	BNPA9A1	BRPA9A1	BWPA9A1
		Φ 15mm×17mm		BRPA902	BWPA902
Analog			GB-NP-N	GB-RP-N	GB-WP-N
Digital Analog			BNPN001	BRPN001	BWPN001

Compatible with **Nobel Biocare® Nobel Replace®**

Product			<i>NP</i>	<i>RP</i>	<i>WP</i>	<i>6.0</i>
Screw			R00SM18	R00SM20	R00SM20	R00SM20
Scan Body			RNPU001	RRPU001	RWPU001	R60U001
Intra-oral Scan Body			RNPU012L	RRPU012L	RWPU012L	R60U012L
Ti-Base		• 4mm Non-Engage	RNPBC00	RRPBC00	RWPBC00	R60BC00
		• 4mm Engage	RNPBC10	RRPBC10	RWPBC10	R60BC10
		• 7mm Non-Engage	RNPBC01	RRPBC01	RWPBC01	R60BC01
		• 7mm Engage	RNPBC11	RRPBC11	RWPBC11	R60BC11
Blank Abutment		Φ 10mm×15mm	RNPA901	RRPA901	RWPA901	R60A901
		Φ 10mm×20mm	RNPA9A1	RRPA9A1	RWPA9A1	R60A9A1
		Φ 15mm×17mm		RRPA902	RWPA902	R60A902
Analog			GR-NP-N	GR-RP-N	GR-WP-N	GR-60-N
Digital Analog			RNPN001	RRPN001	RWPN001	R60N001

GB

GR

Compatible with **Osstem® TS3/Hiossen**

Compatible with **Straumann® Bone Level**







GO

Product			Mini	Standard
Screw			OS01M16	OS01M20
Scan Body			OMIU001	OSTU001
Intra-oral Scan Body			O35U012L	O40U012L
Ti-Base		• 4mm Engage	O35BC12	O40BC12
		• 7mm Non-Engage	O35BC02	O40BC02
		• 7mm Engage	O35BC13	O40BC13
Blank Abutment		Φ 10mm×15mm	O35A903	O40A903
		Φ 10mm×20mm	O35A9A1	O40A9A1
		Φ 15mm×17mm	O35A904	O40A904
Analog			GO-35-N-16	GO-40-N
Digital Analog			O35N001	O40N001

GN

Product			NC	RC
Screw			N00SM16	N01SM16
Scan Body			NNCU001	NRCU001
Intra-oral Scan Body			NNCU012L	NRCU012L
Ti-Base		• 4mm Non-Engage	NNCBC00	NRCBC00
		• 4mm Engage	NNCBC10	NRCBC10
		• 7mm Non-Engage	NNCBC01	NRCBC01
		• 7mm Engage	NNCBC11	NRCBC11
Blank Abutment		Φ 10mm×15mm	NNCA901	NRCA901
		Φ 10mm×20mm	NNCA9A1	NRCA9A1
		Φ 15mm×17mm		NRCA902
Analog			GT-NC-N	GT-RC-N
Digital Analog			NNCN001	NRCN001

Compatible with **Straumann® Tissue Level**

Product				NN	RN	WN
Screw				T00SM18	T00SM20	T00SM20
Scan Body				TNNU001	TRNU001	TWNU001
Intra-oral Scan Body				TNNU012L	TRNU012L	TWNU012L
Ti-Base		Model 1	• 4mm Non-Engage	TNNBC00	TRNBC00	TWNBC00
			• 4mm Engage	TNNBC10	TRNBC11	TWNBC10
			• 7mm Non-Engage	TNNBC01	TRNBC02	TWNBC02
			• 7mm Engage	TNNBC11	TRNBC12	TWNBC12
		Model 2	• 4mm Non-Engage	/	TRNBC01	TWNBC01
			• 4mm Engage		TRNBC10	TWNBC11
			• 7mm Non-Engage		TRNBC03	TWNBC03
			• 7mm Engage		TRNBC13	TWNBC13
Blank Abutment		Model 1	Φ10mm×15mm	TNNA901	TRNA901	TWNA901
			Φ10mm×20mm	TNNA9A1	TRNA9A1	TWNA9A1
			Φ15mm×17mm	/	TRNA902	TWNA902
		Model 2	Φ10mm×15mm		TRNA903	TWNA903
			Φ10mm×20mm		TRNA9A2	TWNA9A2
			Φ15mm×17mm	TRNA905	TWNA905	
Analog				GT-NN-N	GT-RN-N	GT-WN-N
Digital Analog				TNND001	TRND001	TWND001

Compatible with **SIC® Invent**

Product		3.3	4.2
Screw		4200SM16	4200SM16
Intra-oral Scan Body		4233U012L	4242U012L
Blank Abutment		4233A9A1	4242A9A1
Digital Analog		4233N001	4242N001

Compatible with **Zimmer BIOMET 3i® Certain®**

G3

Product			3.4	4.1	5.0
Screw			300SM16	300SM16	300SM16
Scan Body			334U001	341U001	350U001
Intra-oral Scan Body			334U012L	341U012L	350U012L
Ti-Base		• 4mm Non-Engage	334BC00-IN	341BC00-IN	350BC00-IN
		• 4mm Engage	334BC10-IN	341BC10-IN	350BC10-IN
		• 7mm Non-Engage	334BC01-IN	341BC01-IN	350BC01-IN
		• 7mm Engage	334BC11-IN	341BC11-IN	350BC11-IN
Blank Abutment		Φ10mm×15mm	334A901	341A901	350A901
		Φ10mm×20mm	334A9A1	341A9A1	350A9A1
Analog			G3-34-N	G3-41-N	G3-50-N
Digital Analog			334N001	341N001	350N001

Compatible with **Zimmer® Tapered Screw-Vent®**



GZ

Product			3.5	4.5	5.7
Screw			Z00SM172	Z00SM172	Z00SM172
Scan Body			Z35U001	Z45U001	Z57U001
Intra-oral Scan Body			Z35U012L	Z45U012L	Z57U012L
Ti-Base		• 4mm Non-Engage	Z35BC00	Z45BC00	Z57BC00
		• 4mm Engage	Z35BC10	Z45BC10	Z57BC10
		• 7mm Non-Engage	Z35BC01	Z45BC01	Z57BC01
		• 7mm Engage	Z35BC11	Z45BC11	Z57BC11
Blank Abutment		Φ10mm×15mm	Z35A901	Z45A901	Z57A901
		Φ10mm×20mm	Z35A9A1	Z45A9A1	Z57A9A1
Analog			GZ-35-N	GZ-45-N	GZ-57-N
Digital Analog			Z35N001	Z45N001	Z57N001

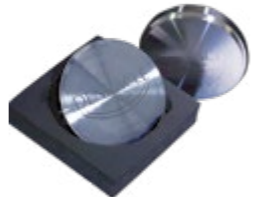

Accessories

Accessories

Product		Spec.	Product Code
Lab Screwdriver		See http://denracle.com for detailed spec.	K00J001
Titanium Disc* (Φ98.5mm)		12mm	A12DRT01
		14mm	A14DRT01
		16mm	A16DRT01
		18mm	A18DRT01
		20mm	A20DRT01
		22mm	A22DRT01
		24mm	A24DRT01
		25mm	A25DRT01
		26mm	A26DRT01
PEEK Disc* Shade: White/Ivory (Φ98.5mm)		12mm	A12DP601
		14mm	A14DP601
		16mm	A16DP601
		25mm	A25DP601

*If your required spec. is not on the list, please contact us.





DENRACLE[®]





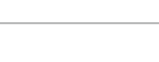

Cutting Tools

Regular Coating Tools



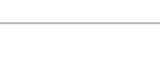

Cutting Tools For ZIRCONIUM, ACRYLIC & PMMA WAX

Product Code		Shank Dia	Head Dia	R	Effect Length	O.A.L	Stop Ring
VZB0314A		3.0	0.3	R0.15	14	40	V
VZB0607A		3.0	0.6	R0.3	7	40	V
VZB1016A		3.0	1.0	R0.5	16	40	V
VZB2020A		3.0	2.0	R1	20	40	V





Cutting Tools For ZIRCONIUM, ACRYLIC & PMMA WAX

Product Code		Shank Dia	Head Dia	R	Effect Length	O.A.L	Stop Ring
WZB0314M		3.0	0.3	R0.15	14	40	V
WZB0707M		3.0	0.7	R0.35	7	40	V
WZB1016M		3.0	1.0	R0.5	16	40	V
WZB2520M		3.0	2.5	R1.25	20	40	V







Cutting Tools For ZIRCONIUM, ACRYLIC & PMMA WAX

Product Code		Shank Dia	Head Dia	R	Effect Length	O.A.L	Stop Ring
VZB0314		3.0	0.3	R0.15	14	35	V
VZB0607		3.0	0.6	R0.3	7	35	V
VZB1014		3.0	1.0	R0.5	14	35	V
VZB2016		3.0	2.0	R1	16	35	V







Cutting Tools For ZIRCONIUM, ACRYLIC & PMMA WAX

Product Code		Shank Dia	Head Dia	R	Effect Length	O.A.L	Stop Ring
WZB0314		3.0	0.3	R0.15	14	35	V
WZB0707		3.0	0.7	R0.35	7	35	V
WZB1016		3.0	1.0	R0.5	16	35	V
WZB2520		3.0	2.5	R1.25	20	35	V









Cutting Tools For ZIRCONIUM, ACRYLIC & PMMA WAX

Product Code		Shank Dia	Head Dia	R	Effect Length	O.A.L	Stop Ring
RZB0610		4.0	0.6	R0.3	14	50	X
RZB0810		4.0	0.8	R0.4	10	50	X
RZB1012		4.0	1.0	R0.5	12	50	X
RZB2016		4.0	2.0	R1	16	50	X
RZB3020		4.0	3.0	R1.5	20	50	X

Cutting Tools For ZIRCONIUM, ACRYLIC & PMMA WAX

Product Code		Shank Dia	Head Dia	R	Effect Length	O.A.L	Stop Ring
AZB0316A		3.0	0.3	R0.15	16	47	V
AZB0610		3.0	0.6	R0.3	10	47	V
AZB1016		3.0	1.0	R0.5	16	47	V
AZB2016		3.0	2.0	R1	16	47	V
AZB2518		3.0	2.5	R1.25	18	47	V







Cutting Tools For ZIRCONIUM, ACRYLIC & PMMA WAX

	Product Code		Shank Dia	Head Dia	R	Effect Length	O.A.L	Stop Ring
ø6	IMZB0616A		6.0	0.6	R0.3	16	50	V
	IMZB1016A		6.0	1.0	R0.5	16	50	V
	IMZB2520A		6.0	2.5	R1.25	20	50	V
	IMZB0316		3.0	0.3	R0.15	16	48	V
ø3	IMZB0610		3.0	0.6	R0.3	10	48	V
	IMZB1014		3.0	1.0	R0.5	14	48	V
	IMZB2520		3.0	2.5	R1.25	20	48	V







Cutting Tools For COBALT-CHROME

	Product Code		Shank Dia	Head Dia	R	Effect Length	O.A.L	Stop Ring
ø6	ICCE1510A		6.0	1.5	D1.5	10	50	V
	ICC0604A		6.0	0.6	R0.3	4	50	V
	ICC1010A		6.0	1.0	R0.5	10	50	V
	ICC1512A		6.0	1.5	R0.75	12	50	V
	ICC2012A		6.0	2.0	R1.0	12	50	V
	ICC3016A		6.0	3.0	R1.5	16	50	V

Cutting Tools For COBALT-CHROME ALLOY







	Product Code		Shank Dia	Head Dia	R	Effect Length	O.A.L	Stop Ring
ø3	ICCE1510		3.0	1.5	D1.5	10	50	V
	ICC0616		3.0	0.6	R0.3	16	50	V
	ICC1010		3.0	1.0	R0.5	10	50	V
	ICC1512		3.0	1.5	R0.75	12	50	V
	ICC2012		3.0	2.0	R1	12	50	V
	ICC3016		3.0	3.0	R1.5	16	50	V

Cutting Tools For TITANIUM ALLOY

Product Code		Shank Dia	Head Dia	R	Effect Length	O.A.L	Stop Ring
ITTE1510A		6.0	1.5	D1.5	10	50	V
ITT0604A		6.0	0.6	R0.3	4	50	V
ITT1010A		6.0	1.0	R0.5	10	50	V
ITT1512A		6.0	1.5	R0.75	12	50	V
ITT2012A		6.0	2.0	R1.0	12	50	V
ITT3016A		6.0	3.0	R1.5	16	50	V

ø6

Cutting Tools For TITANIUM ALLOY





Product Code		Shank Dia	Head Dia	R	Effect Length	O.A.L	Stop Ring
ITTE1510		3.0	1.5	D1.5	10	50	V
ITT0616		3.0	0.6	R0.3	16	50	V
ITT1010		3.0	1.0	R0.5	10	50	V
ITT1512		3.0	1.5	R0.75	12	50	V
ITT2012		3.0	2.0	R1	12	50	V
ITT3016		3.0	3.0	R1.5	16	50	V

ø3





Cutting Tools For **Glaskeramil/e.max Glass ceramic/e.max**

	Product Code		Shank Dia	Head Dia	R	Effect Length	O.A.L	Stop Ring
ø6	IEM0610A		6.0	0.6	R0.3	10	40	V
	IEM1010A		6.0	1.0	R0.5	10	40	V
	IEM2515A		6.0	2.5	R1.25	15	40	V
ø3	IEM0610		3.0	0.6	R0.3	10	40	V
	IEM1010		3.0	1.0	R0.5	10	40	V
	IEM2515		3.0	2.5	R1.25	15	40	V

Cutting Tools For **ZIRCONIUM**

	Product Code		Shank Dia	Head Dia	R	Effect Length	O.A.L	Stop Ring
	ZZB0316A		3.0	0.3	R0.15	16	57	X
	ZZB0516A		3.0	0.5	R0.25	16	57	X
	ZZB1012A		3.0	1.0	R0.5	12	57	X
	ZZB2018A		3.0	2.0	R1	18	57	X





Cutting Tools For **ZIRCONIUM, ACRYLIC & PMMA WAX**

	Product Code		Shank Dia	Head Dia	R	Effect Length	O.A.L	Stop Ring
ø3.5	CZB1020		3.5	1.0	R0.5	20	55	X
	CZB2020		3.5	2.0	R1	20	55	X
	CZB3030		3.5	3.0	R1.5	30	55	X





Cutting Tools For ZIRCONIUM, ACRYLIC & PMMA WAX

	Product Code		Shank Dia	Head Dia	R	Effect Length	O.A.L	Stop Ring
ø6	ARB0610A		6.0	0.6	R0.3	10	50	X
	ARB1014A		6.0	1.0	R0.5	14	53	X
	ARB2020A		6.0	2.0	R1	20	55	X
ø4	ARB0610		4.0	0.6	R0.3	10	50	X
	ARB1016		4.0	1.0	R0.5	16	50	X
	ARB2020		4.0	2.0	R0.15	20	50	X





Cutting Tools For 2 FLUTE *COBALT-CHROME ALLOY

	Product Code		Shank Dia	Head Dia	R	Effect Length	O.A.L	Stop Ring
	ARCC1010		6.0	1.0	R0.5	10	50	X
	ARCC1512		6.0	1.5	R0.75	12	50	X
	ARCC2012		6.0	2.0	R1	12	50	X
	ARCC3016		6.0	3.0	R1.5	16	50	X



Cutting Tools For 2 FLUTE *TITANIUM ALLOY

	Product Code		Shank Dia	Head Dia	R	Effect Length	O.A.L	Stop Ring
	ARTT1010		6.0	1.0	R0.5	10	50	X
	ARTT1512		6.0	1.5	R0.75	12	50	X
	ARTT2012		6.0	2.0	R1	12	50	X
	ARTT3016		6.0	3.0	R1.5	16	50	X







Cutting Tools For ZIRCONIUM, ACRYLIC & PMMA WAX

ø3	Product Code		Shank Dia	Head Dia	R	Effect Length	O.A.L	Stop Ring
	SZB0316		3.0	0.3	R0.15	16	44	X
	SZB0506		3.0	0.5	R0.25	6	44	X
	SZB1018		3.0	1.0	R0.5	18	44	X
	SZB2525		3.0	2.5	R1.25	25	44	X

Cutting Tools For ZIRCONIUM, ACRYLIC & PMMA WAX

Product Code		Shank Dia	Head Dia	R	Effect Length	O.A.L	Stop Ring
YEB0616		4.0	0.6	R0.3	16.0	45	V
YEB1016		4.0	1.0	R0.5	16.0	45	V
YEB2016		4.0	2.0	R1	16.0	45	V

Cutting Tools For ZIRCONIUM, ACRYLIC & PMMA WAX

O.A.L-39L	Product Code		Shank Dia	Head Dia	R	Effect Length	O.A.L	Stop Ring
	3M0614		3.0	0.6	R0.3	14	39	X
	3M1016		3.0	1.0	R0.5	16	39	X
	3M2016		3.0	2.0	R1	16	39	X
O.A.L-50L	3M0616A		3.0	0.6	R0.3	16	50	X
	3M1025A		3.0	1.0	R0.5	25	50	X
	3M2025A		3.0	2.0	R1	25	50	X

DENRACLE[®]



Cutting Tools

Diamond Coating Tools

ø3	Product Code	Shank Dia	Head Dia	R	Effect Length	O.A.L	Stop Ring
	VZD1016A	3.0	1.0	R0.5	16	40	V
	VZD2020A	3.0	2.0	R1	20	40	V

Product Code	Shank Dia	Head Dia	R	Effect Length	O.A.L	Stop Ring
AZD1016	3.0	1.0	R0.5	16	47	V
AZD2518	3.0	2.5	R1.25	18	47	V

Product Code	Shank Dia	Head Dia	R	Effect Length	O.A.L	Stop Ring
RZD1014	4.0	1.0	R0.5	14	50	X
RZD2018	4.0	2.0	R1	18	50	X

ø6	Product Code	Shank Dia	Head Dia	R	Effect Length	O.A.L	Stop Ring
	IMZD1016A	6.0	1.0	R0.5	16	50	V
	IMZD2520A	6.0	2.5	R1.25	20	50	V

Kavo

	Product Code	Shank Dia	Head Dia	R	Effect Length	O.A.L	Stop Ring
ø6/43L	KVD2020	6.0	2.0	R1.0	20	43	X
	KVD1016	6.0	1.0	R0.5	16	43	X

Kavo

	Product Code	Shank Dia	Head Dia	R	Effect Length	O.A.L	Stop Ring
ø6/57L	KVD2020A	6.0	2.0	R1.0	20	57	X
	KVD1016A	6.0	1.0	R0.5	16	57	X

Note



The logo for DENRACLE features the company name in a blue, sans-serif font. Below the text is a stylized yellow smile that curves upwards at both ends. A registered trademark symbol (®) is positioned to the upper right of the text.

DENRACLE[®]

www.denracle.com



Green DenTech Co., Ltd.

2F, No. 17, Deyuanpi Blvd., Danong Vil., Liouying Dist., Tainan City, 73659, Taiwan
TEL/ +886-6-6230999 FAX/ +886-6-6230789 E-MAIL/ sales@denracle.com